



TURBOSWITCH™ ULTRA-FAST HIGH VOLTAGE DIODE

MAIN PRODUCT CHARACTERISTICS

$I_{F(AV)}$	20A
V_{RRM}	600V
t_{rr} (typ)	30ns
V_F (max)	1.5V

FEATURES AND BENEFITS

- SPECIFIC TO "FREEWHEEL MODE" OPERATIONS: FREEWHEEL OR BOOSTER DIODE.
- ULTRA-FAST AND SOFT RECOVERY.
- VERY LOW OVERALL POWER LOSSES IN BOTH THE DIODE AND THE COMPANION TRANSISTOR.
- HIGH FREQUENCY OPERATIONS.
- INSULATED PACKAGE: DOP3I
Electrical insulation : 2500V_{RMS}
Capacitance < 12 pF

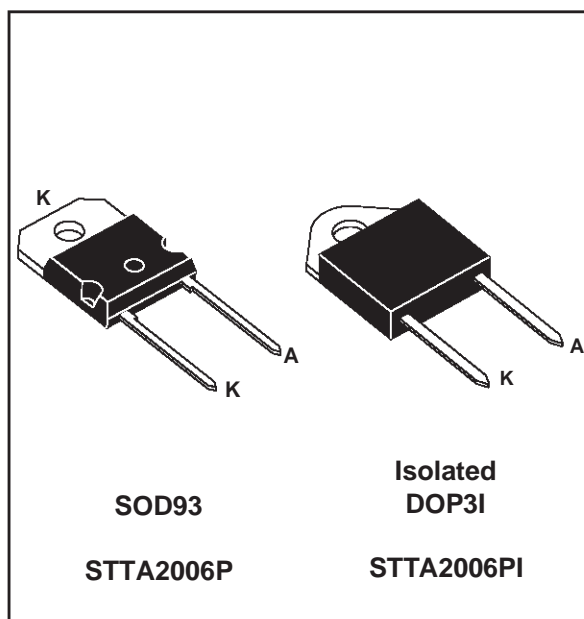

DESCRIPTION

The TURBOSWITCH is a very high performance series of ultra-fast high voltage power diodes from 600V to 1200V. TURBOSWITCH family, drastically cuts losses in both the diode and the associated switching IGBT or MOSFET in all "freewheel mode" operations

and is particularly suitable and efficient in Motor control freewheel applications and in booster diode applications in power factor control circuitries. Packaged either in SOD93 or in DOP3I, these 600V devices are particularly intended for use on 240V domestic mains.

ABSOLUTE RATINGS (limiting values)

Symbol	Parameter	Value	Unit
V_{RRM}	Repetitive peak reverse voltage	600	V
V_{RSM}	Non repetitive peak reverse voltage	600	V
$I_{F(RMS)}$	RMS forward current	50	A
I_{FRM}	Repetitive peak forward current	$t_p = 5 \mu s$ F = 5kHz square	A
I_{FSM}	Surge non repetitive forward current	$t_p = 10$ ms sinusoidal	A
T_j	Maximum operating junction temperature	150	°C
T_{stg}	Storage temperature range	-65 to 150	°C

TM : TURBOSWITCH is a trademark of STMicroelectronics

THERMAL AND POWER DATA

Symbol	Parameter	Test conditions		Value	Unit
$R_{th(j-c)}$	Junction to case thermal resistance	SOD93 DOP3I		1.5 2.1	$^{\circ}\text{C}/\text{W}$
P_1	Conduction power dissipation $I_{F(AV)} = 20\text{A}$ $\delta = 0.5$	SOD93 DOP3I	$T_c = 96^{\circ}\text{C}$ $T_c = 74^{\circ}\text{C}$	36	W
P_{max}	Total power dissipation $P_{max} = P_1 + P_3$ ($P_3 = 10\% P_1$)	SOD93 DOP3I	$T_c = 90^{\circ}\text{C}$ $T_c = 66^{\circ}\text{C}$	40	W

STATIC ELECTRICAL CHARACTERISTICS

Symbol	Parameter	Test conditions		Min	Typ	Max	Unit
V_F^*	Forward voltage drop	$I_F = 20\text{A}$	$T_j = 25^{\circ}\text{C}$ $T_j = 125^{\circ}\text{C}$		1.25	1.75 1.5	V V
I_R^{**}	Reverse leakage current	$V_R = 0.8 \times V_{RRM}$	$T_j = 25^{\circ}\text{C}$ $T_j = 125^{\circ}\text{C}$		2.5	100 6	μA mA
V_{to}	Threshold voltage	$I_p < 3 \cdot I_{AV}$	$T_j = 125^{\circ}\text{C}$			1.15	V
r_d	Dynamic resistance					17	m Ω

Test pulse : * $t_p = 380 \mu\text{s}$, $\delta < 2\%$

** $t_p = 5 \text{ms}$, $\delta < 2\%$

To evaluate the maximum conduction losses use the following equation :

$$P = V_{to} \times I_{F(AV)} + r_d \times I_{F(RMS)}^2$$

DYNAMIC ELECTRICAL CHARACTERISTICS

TURN-OFF SWITCHING

Symbol	Parameter	Test conditions	Min	Typ	Max	Unit
t_{rr}	Reverse recovery time	$T_j = 25^{\circ}\text{C}$ $I_F = 0.5 \text{A}$ $I_R = 1 \text{A}$ $I_{rr} = 0.25 \text{A}$ $I_F = 1 \text{A}$ $di_F/dt = -50 \text{A}/\mu\text{s}$ $V_R = 30 \text{V}$		30	60	ns
I_{RM}	Maximum reverse recovery current	$T_j = 125^{\circ}\text{C}$ $V_R = 400 \text{V}$ $I_F = 20 \text{A}$ $di_F/dt = -160 \text{A}/\mu\text{s}$ $di_F/dt = -500 \text{A}/\mu\text{s}$		17.5	12.5	A
S factor	Softness factor	$T_j = 125^{\circ}\text{C}$ $V_R = 400 \text{V}$ $I_F = 20 \text{A}$ $di_F/dt = -500 \text{A}/\mu\text{s}$		0.42		/

TURN-ON SWITCHING

Symbol	Parameter	Test conditions	Min	Typ	Max	Unit
t_{fr}	Forward recovery time	$T_j = 25^{\circ}\text{C}$ $I_F = 20 \text{A}$, $di_F/dt = 160 \text{A}/\mu\text{s}$ measured at, $1.1 \times V_{Fmax}$			600	ns
V_{Fp}	Peak forward voltage	$T_j = 25^{\circ}\text{C}$ $I_F = 20 \text{A}$, $di_F/dt = 160 \text{A}/\mu\text{s}$			12	V

Fig. 1: Conduction losses versus average current.

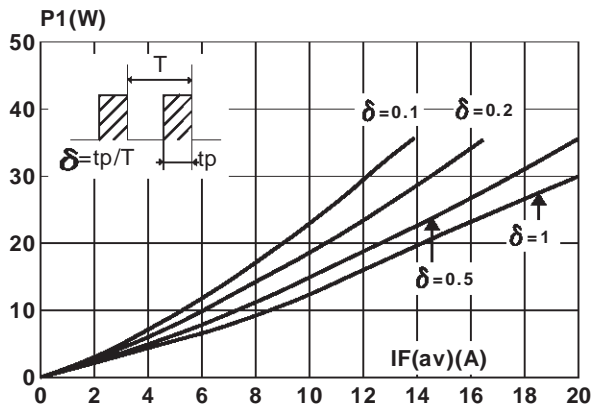

Fig. 2: Forward voltage drop versus forward current.

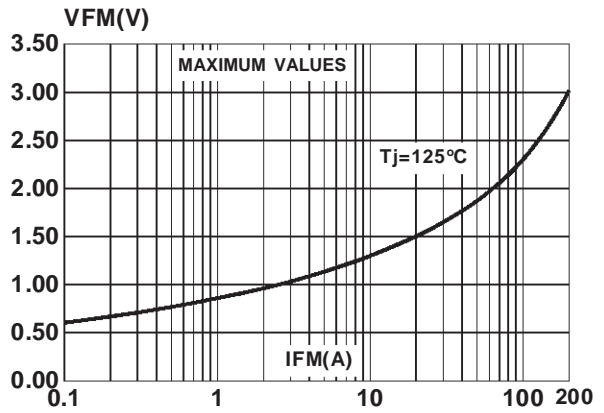

Fig. 3: Relative variation of thermal transient impedance junction to case versus pulse duration.

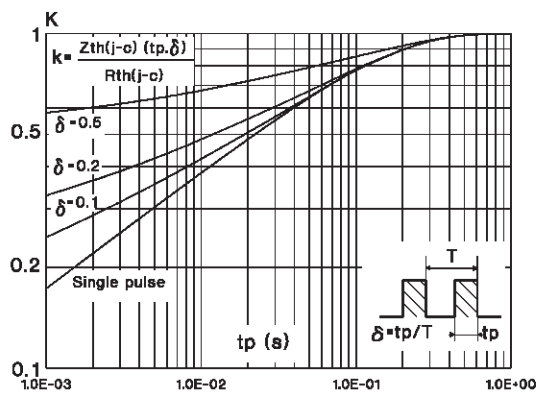

Fig. 4: Peak reverse recovery current versus dIF/dt.

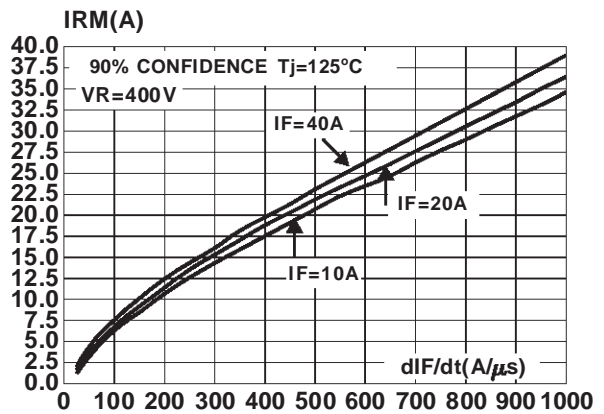

Fig. 5: Reverse recovery time versus dIF/dt.

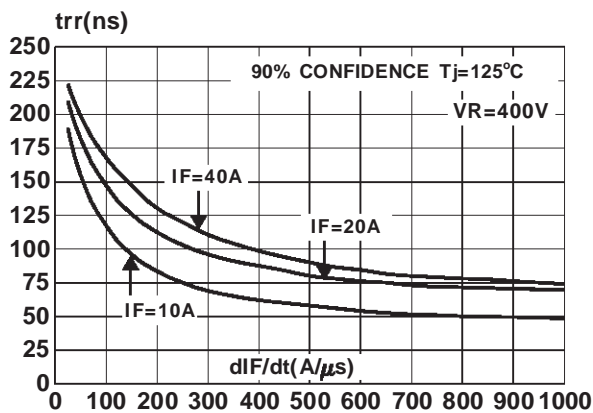

Fig. 6: Softness factor (tb/ta) versus dIF/dt.

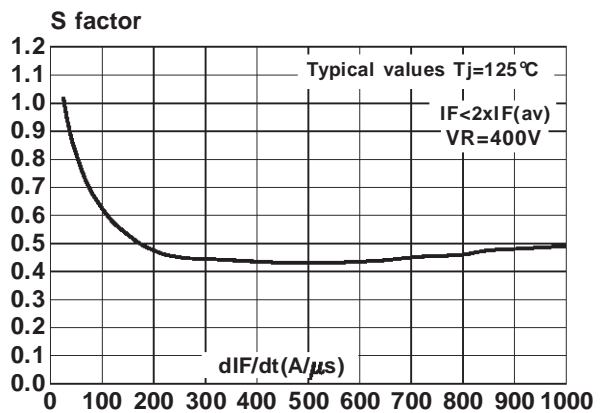

Fig. 7: Relative variation of dynamic parameters versus junction temperature (reference $T_j=125^\circ\text{C}$).

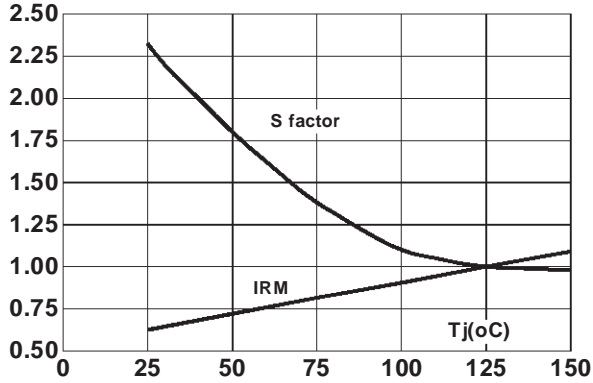

Fig. 9: Transient peak forward voltage versus dI_F/dt .

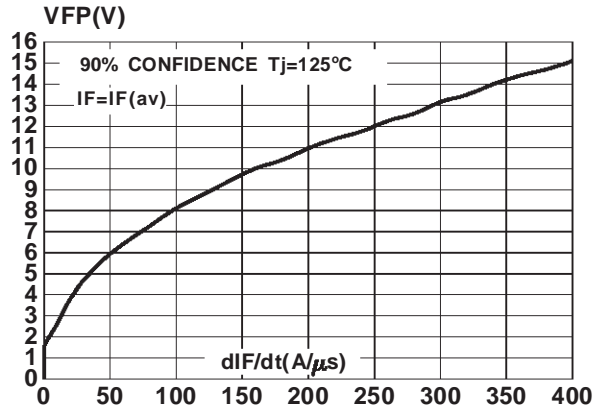
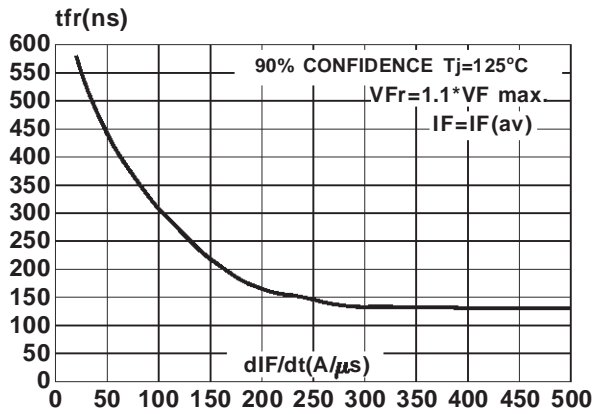

Fig. 9: Forward recovery time versus dI_F/dt .



APPLICATION DATA

The TURBOSWITCH is especially designed to provide the lowest overall power losses in any "FREEWHEEL Mode" application (Fig.A) considering both the diode and the companion

transistor, thus optimizing the overall performance in the end application.

The way of calculating the power losses is given below:

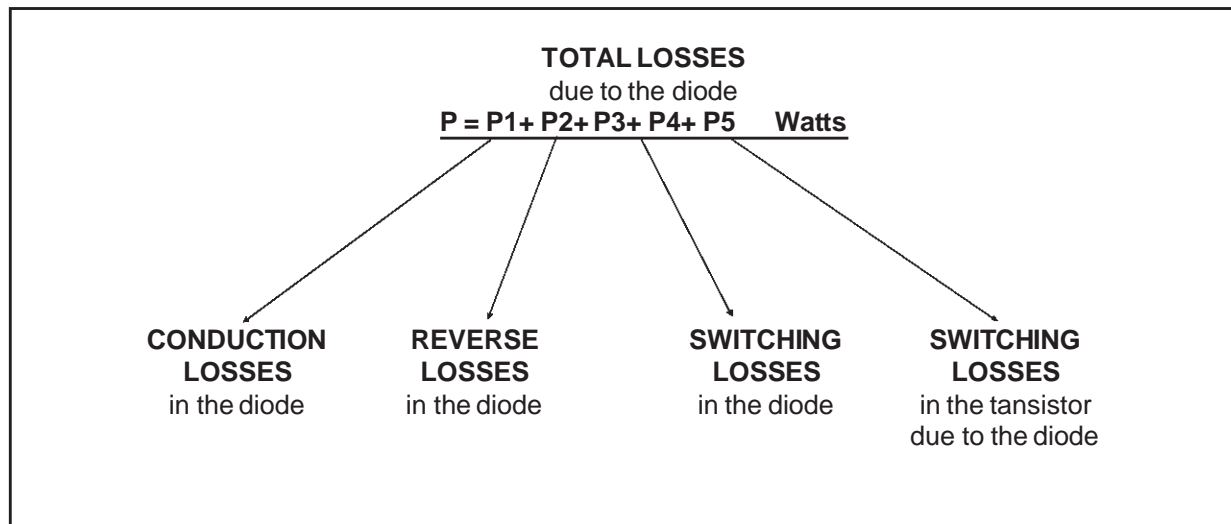
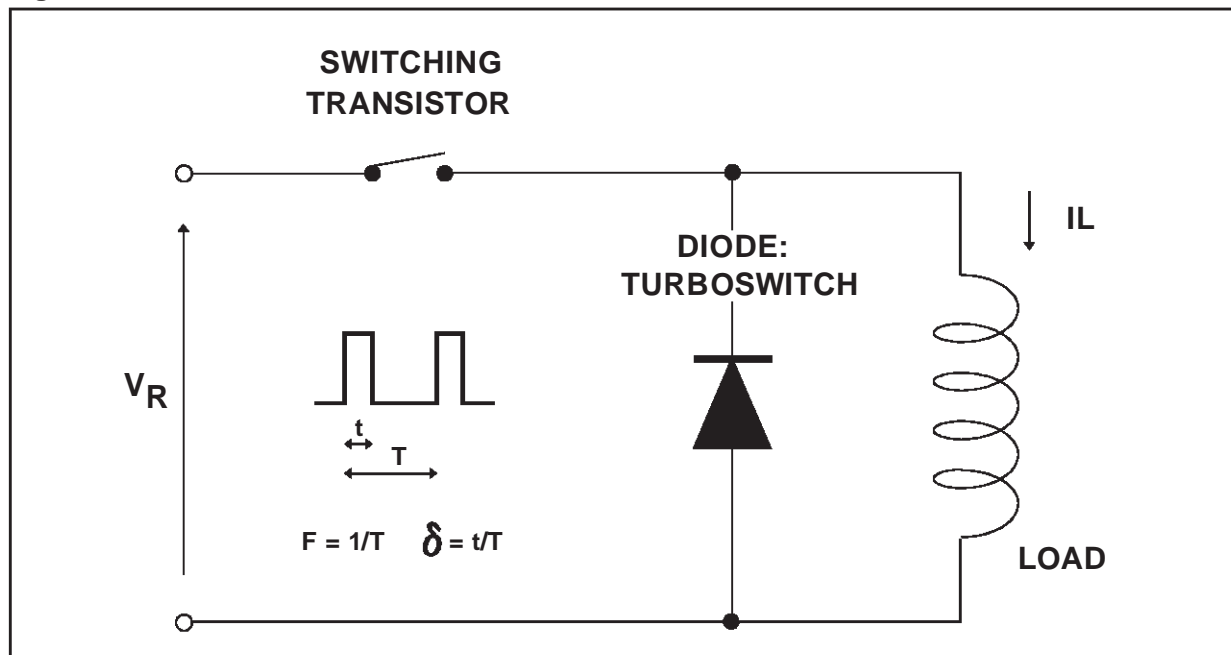
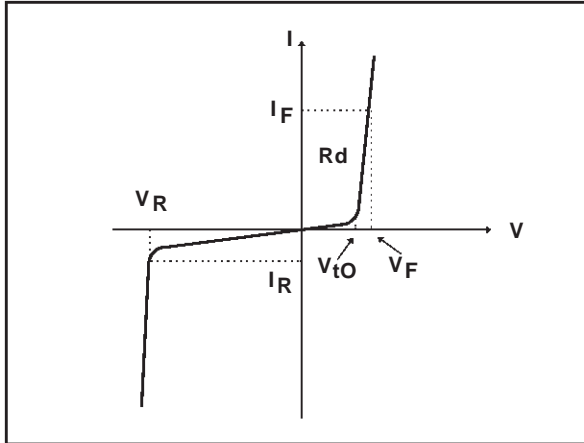

Fig. A : "FREEWHEEL" MODE.



APPLICATION DATA (Cont'd)

Fig. B: STATIC CHARACTERISTICS



Conduction losses :

$$P1 = V_{t0} \cdot I_F(AV) + R_d \cdot I_F^2(RMS)$$

Reverse losses :

$$P2 = V_R \cdot I_R \cdot (1 - \delta)$$

Fig. C: TURN-OFF CHARACTERISTICS

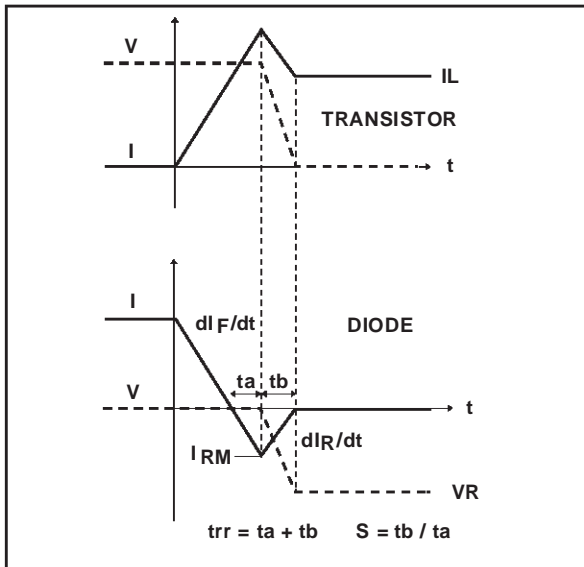

Turn-on losses :

(in the transistor, due to the diode)

$$P5 = \frac{V_R \times I_{RM}^2 \times (3 + 2 \times S) \times F}{6 \times dI_F/dt} + \frac{V_R \times I_{RM} \times I_L \times (S + 2) \times F}{2 \times dI_F/dt}$$

Turn-off losses (in the diode) :

$$P3 = \frac{V_R \times I_{RM}^2 \times S \times F}{6 \times dI_F/dt}$$

P3 and P5 are suitable for power MOSFET and IGBT

Fig. D: TURN-ON CHARACTERISTICS

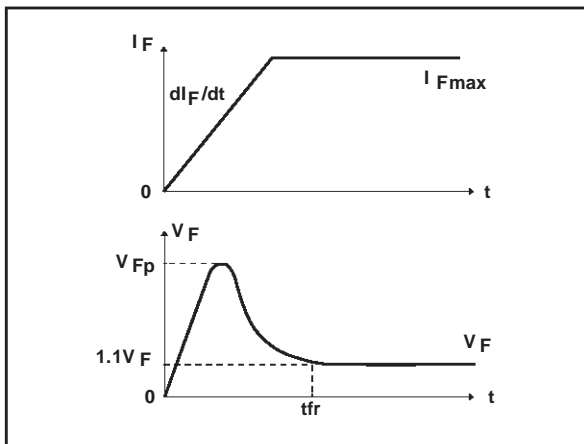

Turn-on losses :

$$P4 = 0.4 (V_{FP} - V_F) \cdot I_{Fmax} \cdot F$$

PACKAGE MECHANICAL DATA
SOD93

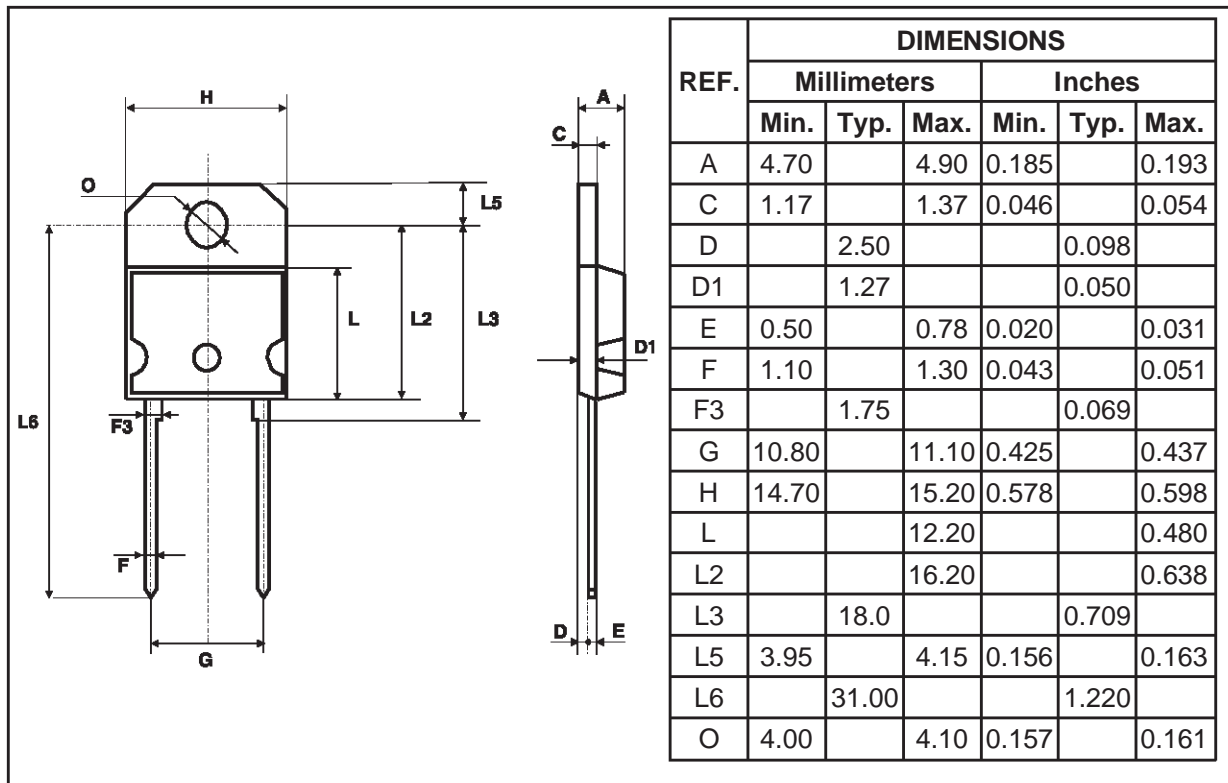

- Cooling method : by conduction (C)
- Recommended torque value : 0.8 m.N
- Maximum torque value : 1.0 m.N

STTA2006P/PI

PACKAGE DATA DOP3I ISOLATED

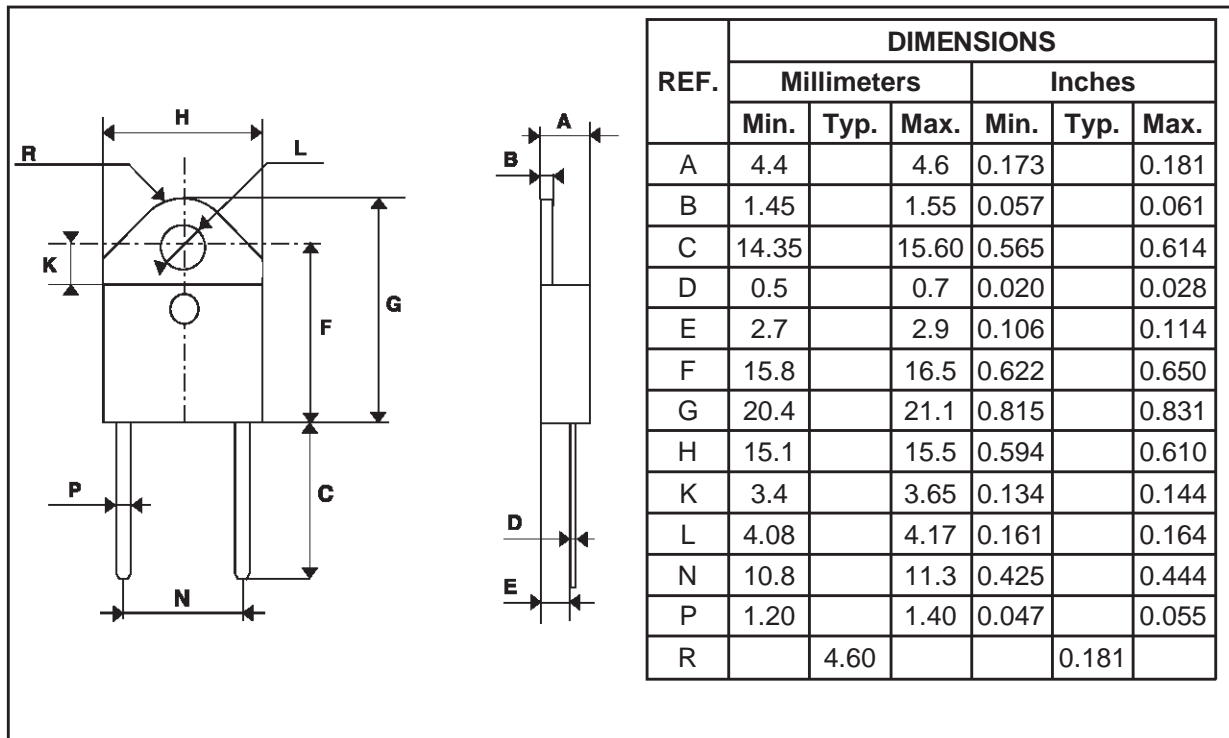

- Cooling method : by conduction (C)
- Recommended torque value : 0.8 m.N.
- Maximum torque value : 1.0 m.N.

Ordering type	Marking	Package	Weight	Base qty	Delivery mode
STTA2006P	STTA2006P	SOD93	3.79g	30	Tube
STTA2006PI	STTA2006PI	DOP3I	4.52g	30	Tube

- Epoxy meets UL94,V0

Information furnished is believed to be accurate and reliable. However, STMicroelectronics assumes no responsibility for the consequences of use of such information nor for any infringement of patents or other rights of third parties which may result from its use. No license is granted by implication or otherwise under any patent or patent rights of STMicroelectronics. Specifications mentioned in this publication are subject to change without notice. This publication supersedes and replaces all information previously supplied. STMicroelectronics products are not authorized for use as critical components in life support devices or systems without express written approval of STMicroelectronics.

The ST logo is a registered trademark of STMicroelectronics

© 1998 STMicroelectronics - Printed in Italy - All rights reserved.

STMicroelectronics GROUP OF COMPANIES

Australia - Brazil - Canada - China - France - Germany - Italy - Japan - Korea - Malaysia - Malta - Mexico - Morocco - The Netherlands - Singapore - Spain - Sweden - Switzerland - Taiwan - Thailand - United Kingdom - U.S.A.

<http://www.st.com>